

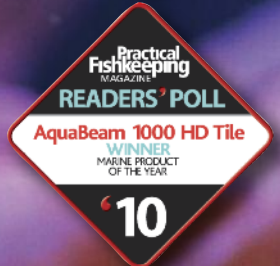

AQUARAY[®]

AQUARIUM LIGHTING

All you need to know about choosing the right lighting for your aquarium



AQUARAY[®]

SOLID STATE LIGHTING

DESIGNED BY TMC

“ In the right light, at the right time, everything is extraordinary ”

AARON ROSE



Contents

1	Why do we need light?	1	5	Your tailor-made solution	14
				AquaRay user guide	16
				Spectrum graphs	26
2	What to consider when choosing your aquarium lights	2	6	Mounting options	28
	Light to illuminate	2		Assembling and using a MountaRay	28
	Light to support life	4		Building your own suspended luminaire	29
3	What types of lighting are available?	6	7	Research & Development	30
	Fluorescent	6		The Future	30
	Metal halide	7		Commercial range	31
	LED	8			
4	Why choose AquaRay?	10			
	Lighting types comparison chart	12			

The tank photos in this brochure have been taken under AquaRay lighting

| Why do we need light?

Light, in the form of the sun, is the source of all energy on our planet.

Along with water it forms one of the basic requirements for life to flourish. Via photosynthesis, light provides food for plants and corals, as well as oxygen for animals to breathe. Rather more obviously, light also allows us to see, and can be used to alter and improve the appearance of objects.

In the context of an artificial habitat such as an aquarium, light should be one of the most important considerations. Not only does it provide nutrients for optimum plant and coral growth, but it can also be used to make colours stand out and even to create a dramatic visual effect within the display.

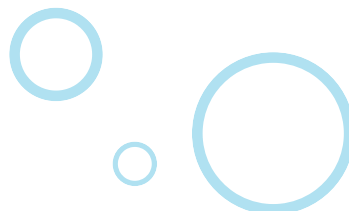

2 What to consider when choosing your aquarium lights

There are two key reasons to light your aquarium - to view the inhabitants and to support life. In this section we cover various aspects of both

Light to illuminate

Lumens

The basic unit of light is the lumen (lm). This is a unit of luminous flux, which is a measure of the power of light perceived by the human eye. Luminous flux is different to radiant flux (measured in Watts) as it is adjusted to reflect the varying sensitivity of the human eye to different wavelengths of light. For our purposes it can be thought of as the total amount of visible light emitted from a source. The more lumens, the brighter the light will look. This doesn't necessarily mean that your tank will look brighter though because it doesn't take into account in which direction that light is going.

Lux

The lux (lx) is derived from the lumen and is a measure of illuminance. This is the luminous flux hitting a surface. This is important because it is effectively the amount of useable light. For example 1000 lumens spread over an area 1m^2 gives you a figure of 1000 lux; however the same amount of light spread over a 10m^2 area gives an illuminance of only 100 lux. In short, illuminance is more relevant to lighting an aquarium than the luminous flux because this is the measure of light that can be applied to your aquarium. This figure will decrease the further from the light source you get, and so when comparing different light sources the measurements should be taken at the same distance.

Spread

It is important to get a reasonable spread of light in your aquarium. This will allow you to view as much as possible and to get an even lighting effect. This can be affected by the type of reflector or lenses used on a light.





Colour rendition Lighting effects

The colour of light used is critical if you want your aquarium to look its best. Reds will wash out under only blue light and similarly blues will not look good under red light. It is important to choose a light that picks out the colours that you want to show off. If you want luscious green-looking plants in your aquarium then a warmer white light will work well (see Colour Temperature overleaf).

Although spread is important, light and dark can be used in an aquarium to achieve dramatic effects. Think about varying light levels throughout your aquascape. Perhaps use a spotlight to highlight your favourite coral specimen. Or directed light to cast shadows in your planted tank. Remember you are making a display so think of it as lighting a stage!

TIP



Always check the lighting requirements of the animals you are keeping.

Some need lots of light to survive, whilst others prefer shaded spots.

“ To love beauty is to see light ”

VICTOR HUGO



Light to support life

Always refer to your local fish stockist with regards to the requirements of your particular species

Wavelength and spectrum

Visible light is actually a form of electromagnetic radiation that our eyes are sensitive to. This means that it can be thought of as waves of energy radiating through space. The length of one of those waves defines the colour of the light and for visible light it is measured in hundreds of nano meters (nm). For example violet radiation is about 410nm-440nm, then comes blue at 440-460nm. This continues through all colours of the rainbow until we get to red at around 700nm. When these wavelengths are combined, different colours can be made – for example 450nm (blue) and 700nm (red) would look like purple light to us.

When most of the colours are represented in fairly balanced amounts (particularly red, blue and green), then the human eye will see it as white light. The amount of each colour in a light is called its spectrum (see example). A good spectrum will be as close to natural sunlight as possible which means there will be light present from every wavelength throughout the visible spectrum.

Photosynthesis is a process that both plants and most corals use to turn light into food. This process allows these organisms to grow and flourish and, without this light, they would die.

PAR (Photosynthetically Active Radiation) is the measure of light within the range of wavelengths used by photosynthetic organisms (400-700 nanometers). It is measured in microEinsteins/m²/second. In physics, light is thought of as particles of energy, or photons. An Einstein is one mole of photons, where a mole is the number of carbon atoms in 12g of carbon (6.0221415×10^{23}).

Like illuminance, PAR measurements will decrease the further from the source you get, and so when comparing different lights the measurements should be taken at the same distance.

So, PAR is basically a measure of the amount of light that photosynthetic organisms can use, and photosynthetic organisms include the plants and corals in your aquarium. This makes it an important factor in choosing your lights. If you are keeping certain species that require a lot of light then you need high PAR levels. This doesn't necessarily mean getting the brightest light you can, because the quality of the spectrum of light is important.

Example colour spectrum

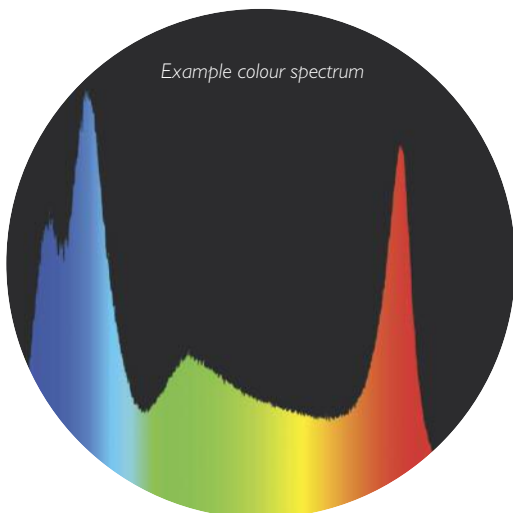

“ Light is important to us humans. It influences our moods, our perceptions, our energy levels.”

JOHN MARSDEN



Some lights can provide broken spectrums which mean that although it is delivering high amounts of light in certain colours, it is lacking in others. The light may still appear to be white, but it may have serious deficiencies. PAR is therefore a good indicator of what will work over your aquarium.

PUR stands for Photosynthetically Useable Radiation. This is even more useful than PAR as whilst PAR is what an organism *can* use, PUR is what it actually *does* use. Unfortunately this is impossible to test for as it differs from species to species. It is worth noting though that high PAR does not guarantee good results.

Photoinhibition

Unfortunately it isn't quite as easy as just putting as much light as possible over your aquarium. There is a point at which light becomes damaging to plants and corals in that it actually reduces the ability to photosynthesise. Plants can get burnt and wither and corals can bleach. It is important that you recognise this when choosing your lighting and make sure you don't "overdo it".

Light penetration

As light passes through water it loses energy and is eventually absorbed completely. This means that it is important that the light you use has enough energy to pass through the depth of water for the tank you are trying to light.

Generally speaking this isn't usually a problem unless you have a deep tank and want to keep animals that need high light levels at the bottom of the tank. Ways to ensure good penetration of light is to use very high power lights (this method can be quite wasteful), or to focus the light to make sure that it reaches to where you need it.

Colour temperature

As light is absorbed by water, it changes colour because the longer wavelengths are absorbed first. This is one of the reasons that deep water can sometimes look blue. This means that certain corals are adapted to a more blue-coloured white light. Colour temperature is a way to describe the colour of a white light. It is based on the colour that a black body radiator will go as it is heated to very high temperatures and is measured in Kelvin (K), which is a unit of temperature used in physics. So, at 3500K the white light is yellowy – like a standard light bulb. Natural daylight on a bright sunny day is considered to be 6500K. The more blue-whites that are good for keeping marine animals are at around 10000-20000K. Rather strangely the colours known as "warmer whites" (i.e. the more yellowy whites) are actually cooler colour temperatures (i.e. lower numbers). The "cool whites" are more blue and have higher colour temperatures. Be careful not to get confused here!!

FACT



When changing lighting, you should expect a transition period where the plants and animals are adjusting to the new set up. This can sometimes take a few weeks.

3 What types of lighting are available?

There are three main types of lighting that can be used on aquaria - fluorescent, metal halide and LED.

Occasionally another type will emerge (plasma lighting for example) but the three types listed above are the main staples for most aquarists

Before the emergence of high power LEDs, the aquarist would have had a fairly easy decision to make on whether to use metal halide or fluorescent lighting as they each have very clear and different advantages/disadvantages. LED lighting is now able to outperform these technologies in most cases, but there are still important considerations to take into account.

Fluorescent

A fluorescent tube is a low pressure mercury vapour held in a glass tube. When a large voltage is applied across this tube it causes the gas to become a plasma which emits short wave UV light. The glass tube has a phosphor coating which fluoresces to convert the UV light to visible light.

The advantage of this technology is that it is quite energy efficient (around 70-100lm/W) and is available with fairly low power consumption (usually 18-80W). However, light is thrown in all directions and so an inefficient reflector is needed to direct the light into the aquarium. This reflector will also direct heat into the water. Over the years it has proven to be an acceptable way to light an aquarium, however the quality of the light is not that great as the white light produced has a very broken spectrum.

This spectrum also degrades further as the phosphor breaks down due to the heat of the plasma. This results in a need for regular lamp changes which of course costs money. There is also a safety issue with this technology as it means having mains voltage over the tank, with the associated risks of electric shock, and the lamps are fragile glass and can break easily. Broken glass in itself is dangerous, but a breakage can also release mercury and phosphor powder, potentially poisoning your aquarium.

Practically speaking, there are lots of fittings of varying sizes available and whilst they can be dimmed, this requires special equipment which is quite expensive and rarely seen in the hobby. They can be installed in a variety of ways including tank mounting, suspending from the ceiling and fitting within a hood.



“ May it be a light to you in dark places, when all other lights go out ”

JRR TOLKIEN

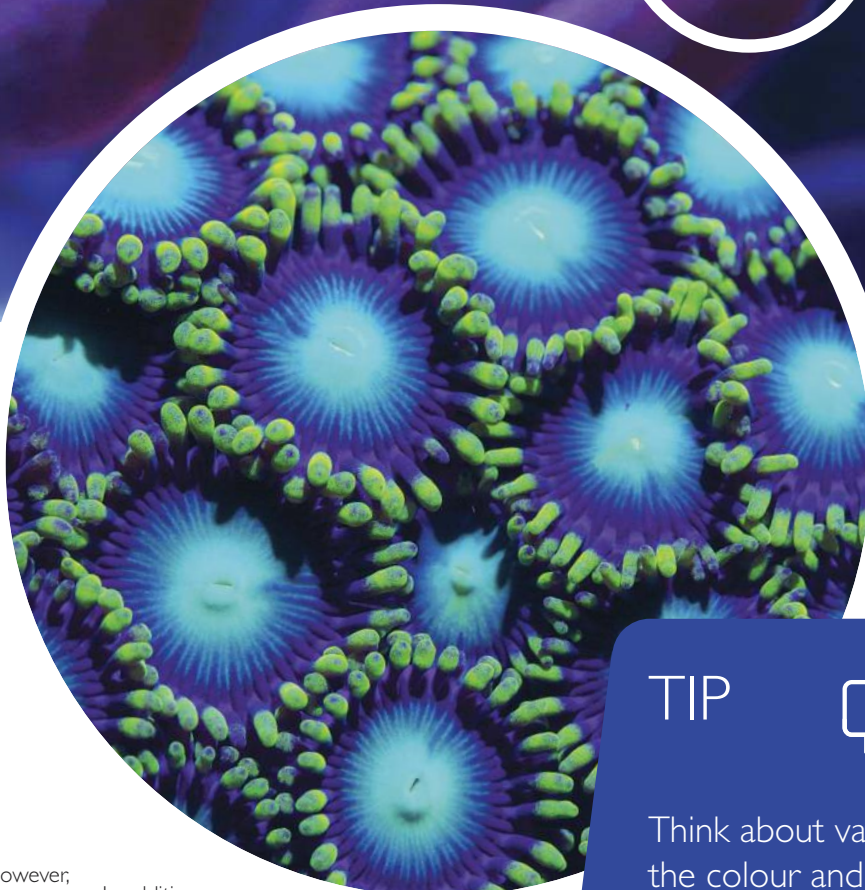

Metal Halide

This is also based on mercury vapour. However, this high pressure, gaseous mixture contains metal halides to improve the efficacy and colour rendition of the light. This is also an energy efficient light source (around 75-100lm/W), but it is only available with much higher power consumptions (70-400W). Until LED, this was the best way to get a large amount of light over an aquarium and also to achieve a great shimmer effect due to it being a point light source. It is, however, very expensive to run due to the high power needed and the high cost of replacement lamps. As with fluorescent lighting it requires a reflector and also creates a broken spectrum.

In addition to this, it pumps out a huge amount of heat, usually resulting in the need for a chiller to keep the temperature of the aquarium at the correct level. Once again there is mains voltage over the tank and the lamps are made of glass and ceramic with mercury inside, all of which are major drawbacks to the technology.

With regards to mounting options, metal halides are big and heavy and can only really be suspended from the ceiling or a wall bracket. They are also not dimmable.

TIP



Think about varying the colour and lighting levels throughout your aquarium. This can create some very dramatic effects and give a real sense of depth.

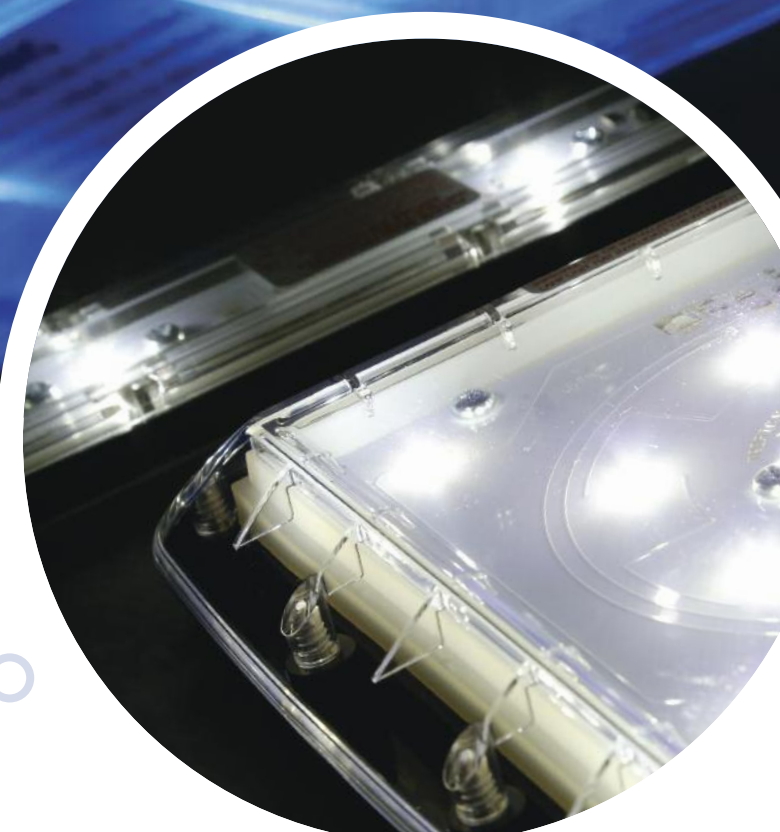
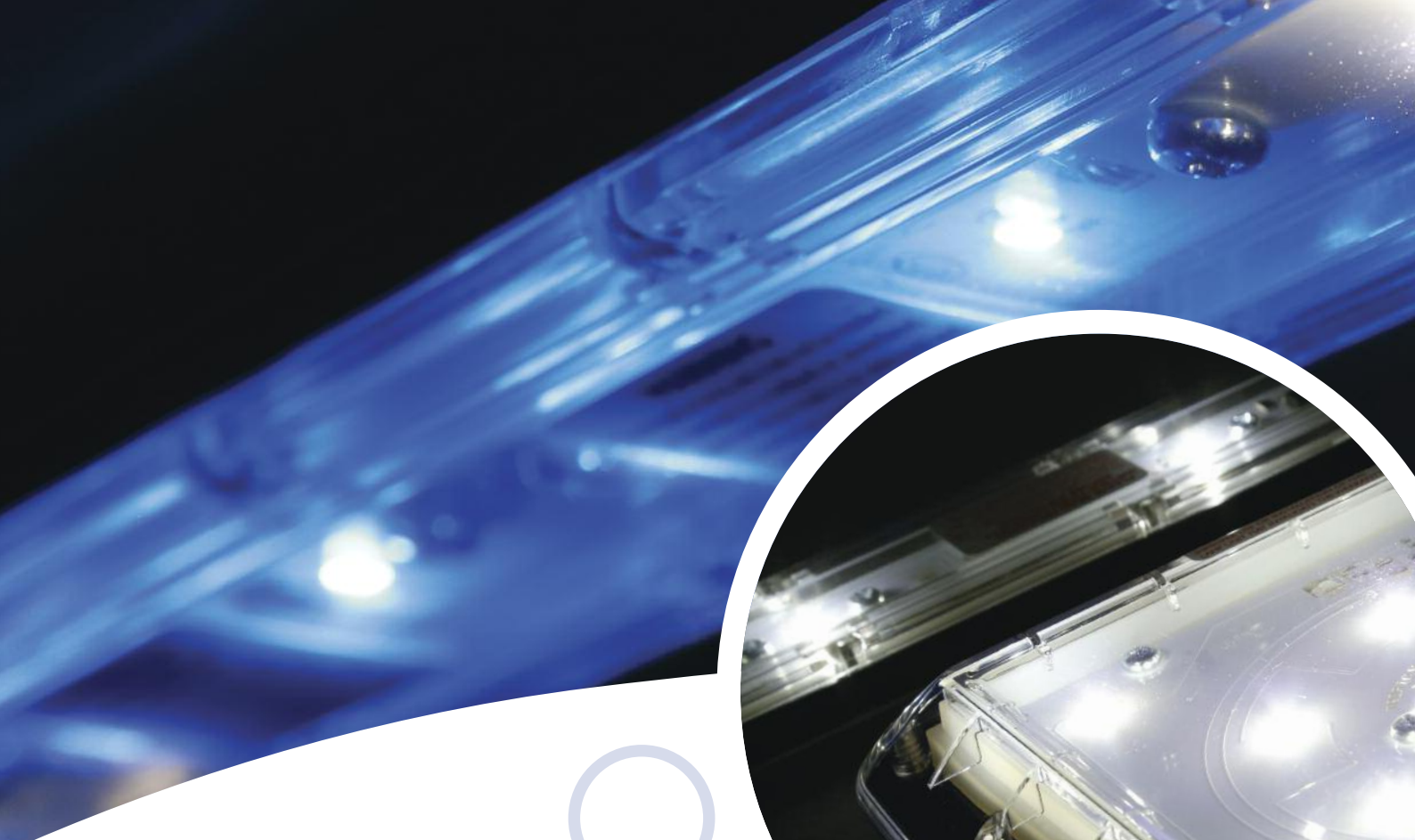

FACT



Whilst blue “moonlight” bulbs really get your corals fluorescing, we all know it doesn’t really look like true moonlight. Get the best of both worlds with AquaRay’s patented Nature Perfect™ technology. This uses a special blue LED that has a white shift to the spectrum, making your tank look more like a natural reef.



LED

This technology is relatively new to aquarium lighting, but has taken the hobby by storm due to its longevity and practicality. It is based on semiconductor technology that emits visible light when a current is passed through it. White LEDs are based on chips, also known as dies, which emit blue light but have a stable phosphor coating that converts the light into a nice smooth white spectrum. This is why white LED spectra always have a spike in the blue area. They are extremely efficient (up to around 120 lm/W and improving all the time), but to reach this potential it is very important that they are used correctly. LEDs become less efficient when they are run at higher currents, and it is critical that they are kept cool. This means that they need a suitably-sized heat sink (a chunk of aluminium used to dissipate heat), a good thermal path (achieved by using thermally conductive materials right through from the LED to heat sink), and if needed, some forced cooling such as fans.

It is difficult to make quick comparisons between LED and other lighting types, because the light produced by an LED is used more effectively. On paper it may produce less light in terms of lumens, but all that light is directed straight down into the aquarium and does not spill out through the glass or over the top of the tank. This is why PAR and lux measurements are more relevant when making comparisons (see page 2). Sometimes an aquarium with LED lighting may not look as bright as when it is lit by other technologies, even though it actually has the same or possibly more light over it. This is because the angle of most of the light beams hitting the inside of the glass is larger than the critical angle, meaning that the light is reflected back into the aquarium rather than passing through the glass and hitting your eyes. This can be proven using light meters inside and outside the aquarium. So the great thing about LEDs is that they can make your aquarium a very attractive feature instead of an overbearing focal point that lights up the entire room!

“ No one lights a lamp in order to hide it behind the door: the purpose of light is to create more light, to open people's eyes, to reveal the marvels around...”

PAULO COELHO

Despite the need for cooling, LEDs can be incorporated into slim, lightweight fittings, which are generally quite rugged as well as being mercury free.

More affordable options are becoming available and, if used correctly, the running costs are low, with no lamp changes required. They are highly controllable, enabling shifts in colour, dimming, and even special lighting effects such as cloud and lightning simulation as well as red light for nocturnal viewing.



4 Why choose AquaRay?

Not all LED lighting is the same. LED can have high energy costs if you choose a large fitting with lots of power. They can also be inefficient due to simply running the LEDs as hard as possible. Most importantly they can be unreliable if not designed properly

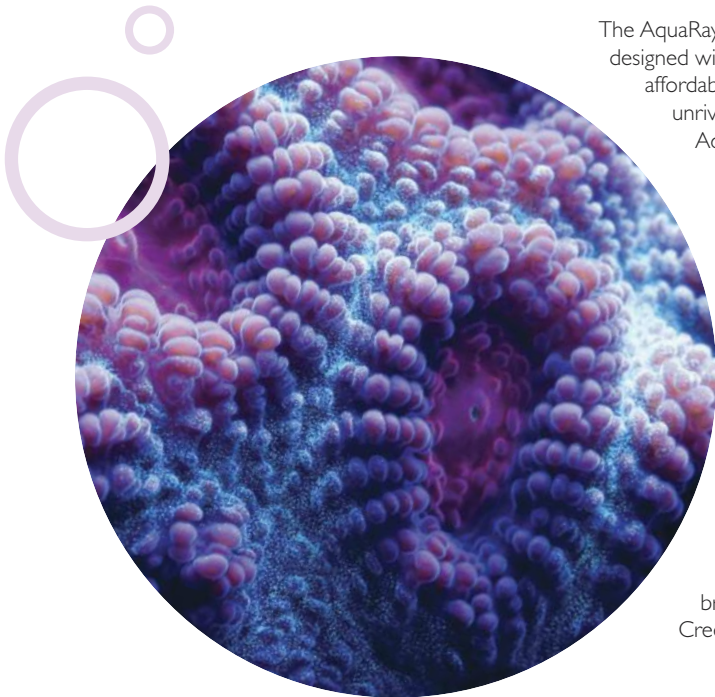

The AquaRay LED Lighting System has been designed with reliability, efficiency and affordability in mind and comes with an unrivalled 5 year guarantee on the AquaBeam strips and tiles.

Tropical Marine Centre has worked closely with LED manufacturers since 2007 to ensure that its AquaRay lighting is effectively cooled without the need for fans, which can be noisy and will fail in time.

The LEDs are run at their optimal drive current, which means that the highest lumens per watt ratio is achieved.

AquaRay only uses high quality branded components such as Cree®, Osram and Samsung and

these components are encased in a rugged, waterproof housing to ensure a top level of protection from everyday use over an aquarium.

The modular design of the AquaRay system allows you to simply buy the right amount of lighting for your aquarium meaning a cheaper entry point and a system that can grow as you move onto larger setups. All the units create a fantastic “shimmer” effect and produce realistic colours and controllers are available separately.

Unfortunately some LED luminaire manufacturers use unbranded components, forced cooling via a fan and overpowered units. On top of this the guarantees they offer are usually no more than a year so what happens if a fan fails and the LEDs overheat? And what if there is a component failure outside of the guarantee period? In fact, why even bother to use LED technology if you're not saving energy?

Why choose AquaRay?

Needless to say, you don't have to worry about any of this with AquaRay.

What's more, there is a huge range of mounting options available within the range, using the clever AquaRay MMS Modular Mounting System. This is based around an aluminium rail that actually improves the heat sinking and therefore the unit's overall performance.

AquaRay can even be installed inside a hood

due to the waterproof construction of the lighting units.

If you are looking for a high quality lighting system backed up by a high level of support and the longest guarantee in the industry, it really is a no-brainer!

This is why AquaRay has won "Marine Product of the Year" in Practical Fishkeeping Magazine's Readers' Poll for FIVE years running.



TIP



Think longer-term when buying your aquarium lighting. Is there a possibility you'll need more light in the future, and if so is your proposed set up expandable?

AQUARAY®

Power consumption per unit	✓✓✓	Low IIW - 30W
Efficiency	✓✓✓	Designed to be MORE energy efficient
Colour range	✓✓✓	All colours from near UV blue to red
Efficacy	✓✓✓	Directional - all light goes towards the tank and can be focused with use of lenses. Beam angle 60 - 120°
Digitally controllable/dimmable	✓✓✓	Yes/yes
Special lighting effects	✓✓✓	Sunrise/sunset, lunar cycles, moonlight, clouds/storm functions, bio-fluorescence, mood lighting
Energy radiated as heat	✓✓✓	Low - fitting can be handled
Bulb life/av. 5 year lamp replacement cost	✓✓✓	>50,000 hrs/nil
Shimmer effect	✓✓✓	Yes
Cost of light fitting	✓✓	Affordable options
Form of light fitting	✓✓✓	Compact and lightweight
Modular and expandable	✓✓✓	Yes to suit lighting requirements
Suitability for sizes of tanks	✓✓✓	All sizes from nano to large tanks
Fixing options	✓✓✓	Suspended, on-tank and in- Hood
Noise	✓✓✓	Silent - no fans
Water - resistance	✓✓✓	IP67
High voltage/electric shock risk with water ingress	✓✓✓	Low voltage/no risk
Corrosion/impact resistance	✓✓✓	High/high
Environment I - carbon foot print	✓✓✓	Small
Environment II - mercury present	✓✓✓	None
Guarantee	✓✓✓	5 years
Made in UK	✓✓✓	Yes
Av. annual electricity cost per unit	✓✓✓	£12
Total av. 5 year running costs/unit (incl.bulb replacement)	✓✓✓	Less than half the purchase cost of a unit
Made by TMC	✓✓✓	Yes

AQUARAY®



LARGE LED LIGHT FITTING

- High 90W - 250W
- Energy efficient
- All colours from near UV blue to red
- Directional - all light goes towards the tank and can be focused with use of lenses.
Beam angle 40 - 120°
- Yes/yes
- Sunrise/sunset, lunar cycles, moonlight, clouds/storm functions, bio-fluorescence, mood lighting
- Medium - fitting may need a fan for cooling
- <50,000 hours/nil
- Yes
- Expensive
- Medium size and weight
- No
- Medium to large tanks
- Suspended and on-tank only
- Noise from fans
- Spray-proof
- Low voltage/medium risk
- High/medium (can have glass)
- Medium
- None
- 1 - 3 years
- No
- £77
- Same as purchase cost of unit
- No

LARGE LED LIGHT FITTING

GAS DISCHARGE - METAL HALIDE/SODIUM

- High 75W - 400W
- Energy efficient
- Near UV blue to warm white
- Undirectional - 360°
- Needs a reflector to direct light towards tank surface. Reflected light = inefficient & MORE HEAT
- No/no
- None unless combined with other lighting types
- High - lamp extremely hot. Water may need chiller
- 5,000 hours/£450
- Yes
- Expensive
- Large, bulky and heavy
- No
- Large tanks only
- Suspended only
- Noise from control gear
- Splash-proof
- High voltage/high risk
- Medium/low - fragile (ceramic, glass)
- High
- Yes
- 1 year
- No
- £120
- Three times the cost of the unit
- No

GAS DISCHARGE - METAL HALIDE/SODIUM

FLUORESCENT - LINEAR/COMPACT FITTING

- Medium 18W -75W
- Energy efficient
- near UV to warm white
- Undirectional - 360°
- Needs a reflector to direct light towards tank surface. Reflected light = inefficient & MORE HEAT
- No/no
- Only bio-fluorescence unless combined with other lighting types
- Medium - lamps hot
- 15,000 hours/£100
- No
- Affordable options
- Normally large/heavy, some compact fittings
- No
- Medium - large tanks
- Suspended, on-tank and in-hood
- Silent - no fans
- Spray-proof
- High voltage/high risk
- Medium/low-fragile (glass)
- Medium
- Yes
- 1 year
- No
- £36
- Two times purchase cost of the unit
- No

FLUORESCENT - LINEAR/COMPACT FITTING

5 Your tailor-made solution

One of the great features of LED technology is the wide range of different coloured diodes that are now available

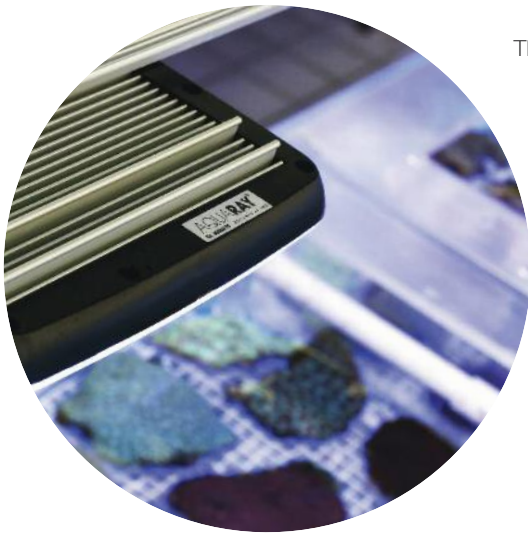

This colour range means we can now provide a lighting solution that both closely matches the natural environment of the fish, corals, plants and other animals we collect, as well as highlighting their particular colours and features.

Many manufacturers have failed to take advantage of the range of choice available to them. By building large, single-unit luminaires with large quantities of individual diodes, they fail to maximise the flexibility that the technology offers.

From the very beginning of the AquaRay story, we recognised that this flexibility was a key benefit of the technology. By providing an extensive range of small, modular units, each made up of different types and colours of diodes, we bring a unique solution - the ability to combine any product from the range into a single, customised array, scalable to fit over small or large aquaria, and suitable for any biotope, from planted freshwater through to the most demanding full-reef marine display.

Passively cooled and compact, our modular units can easily be installed in most standard aquarium hoods, mounted and suspended using our own, purpose-built MMS Modular Mounting System, or otherwise integrated using a growing number of different fittings.

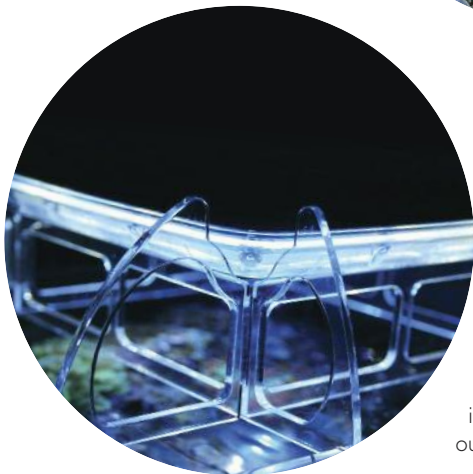
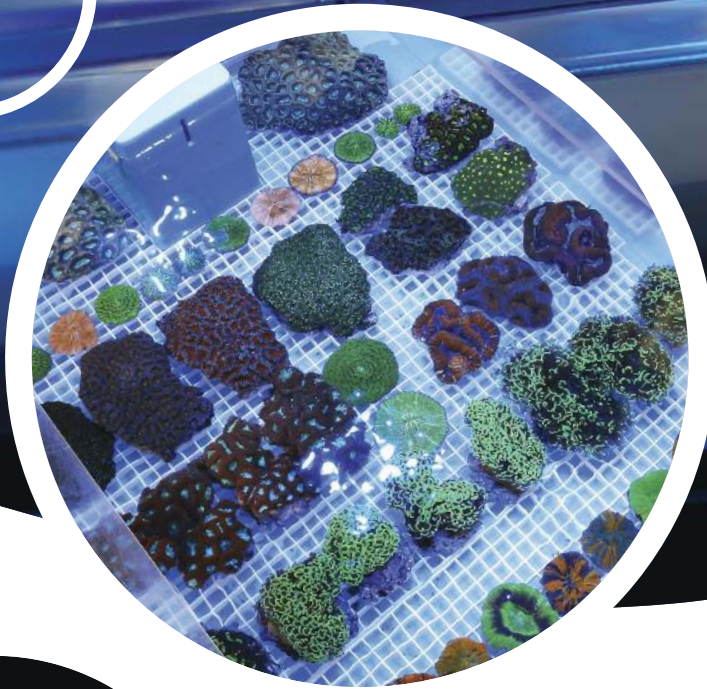

We can now also easily program our LED lights to simulate the different phases of the day as they would occur in nature. This means a natural, stress-free dawn with the lights gradually dimming up in the morning, and a relaxed, smooth fade-out at the end of the day.

TIP



Whilst spectrum is important for corals, the ratio of blue to white doesn't make a vast amount of difference to them. Therefore as long as there is some white light, the colour choice is more about how you like your aquarium to look. Typically we would suggest a roughly 40/60 split of blue to white.

MiniLED 500HD tile over a MicroHabitat 30 tank with light in "moonlight" mode.



DESCRIPTION		CODE	Freshwater/planted	Tropical/marine fish only	Marine with soft corals	Full reef
600 Single	Natural Daylight	2703-UK	◆◆	◆◆		
600 Twin	Natural Daylight	2710-UK	◆◆	◆◆		
600 Single	Marine White	2704-UK		◆◆	◆◆	◆
	Reef White	2705-UK		◆◆	◆◆	◆
	Marine Blue	2706-UK		◆◆	◆◆	◆
	Reef Blue	2707-UK		◆	◆	◆
	Fiji Blue	2708-UK		◆	◆	◆
	NUV	2709-UK		◆	◆	◆
600 Twin	Marine White	2711-UK		◆◆	◆◆	◆
	Reef White	2712-UK		◆◆	◆◆	◆
	Reef Blue	2714-UK		◆	◆	◆
	Fiji Blue	2715-UK		◆	◆	◆
600 Combo	Combo RB/MW	2716-UK		◆◆	◆◆	◆
	Combo RW/MB	2717-UK		◆◆	◆◆	◆
	Combo FB/RB	2718-UK		◆	◆	◆
MiniLED	400	1860-UK	◆◆	◆◆		
	500	1861-UK			◆◆	◆◆
1000	Colour Plus	1906-UK	◆◆	◆◆		
1500	Natural Daylight	1911-UK	◆◆	◆◆		
	Colour Plus	1916-UK	◆◆	◆◆		
	Ocean Blue	1915-UK		◆◆	◆◆	◆
2000	Reef White	1913-UK			◆◆	◆◆
Flexi-LEDs	AquaWhite Flexi Single	1889-1-UK	◆◆	◆◆	◆	
	AquaWhite Flexi Twin	1889-2-UK	◆◆	◆◆	◆	
	AquaRed Flexi Single	1885-UK	◆	◆	◆	◆
	AquaBlue Flexi Single	1888-UK	◆	◆	◆	◆
AquaBar	500 Freshwater	1770	◆◆	◆◆		
	1000 Freshwater	1771	◆◆	◆◆		
	500 Marine	1772		◆◆	◆◆	◆
	1000 Marine	1773		◆◆	◆◆	◆
DESCRIPTION		CODE	Freshwater/planted	Tropical/marine fish only	Marine with soft corals	Full reef

LEGEND

- ◆◆ sole lighting source (may need multiples depending on tank size)
- ◆ supplementary only/accessory

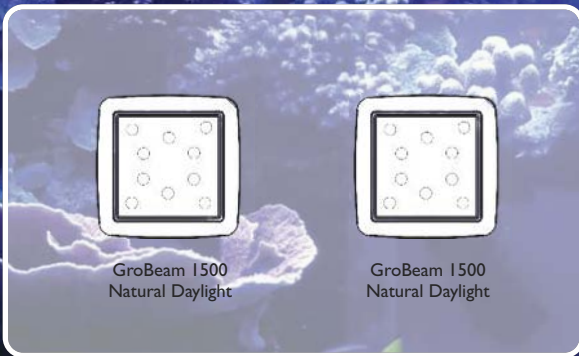

Suggested configuration for a 60cm x 45cm planted aquarium
Based on a TMC Signature 60 x 45 x 30cm Aquarium.

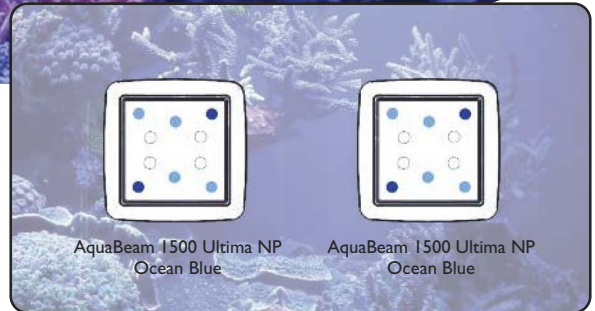

Suggested configuration for a 90cm x 45cm marine aquarium
(fish, live rock and soft corals).
Based on a TMC Signature 90 x 45 x 45 Aquarium.

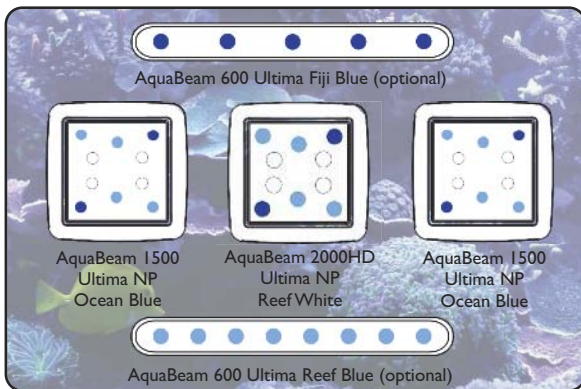

Suggested configuration for a 90cm x 45cm marine aquarium
(fish, full reef)
Based on a TMC Signature 90 x 45 x 45 Aquarium.



Today, our extensive range provides all the options you will need to light your aquarium, both for visual effect, as well as according to its biological requirements, be it planted freshwater, or marine coral reef.

GroBEAM

600 Ultima

Solid State Lighting Strip
for freshwater applications

2703	Natural Daylight (6500K white) Single Strip	1
2710	Natural Daylight (6500K white) Twin Strips	2

AQUABEAM

600 Ultima

Solid State Lighting Strip
for marine applications

2704	Marine White (14000K white) Single Strip	3
2705	ReefWhite (18000K white) Single Strip	4
2706	Marine Blue (20000K white) Single Strip	5
2707	Reef Blue (465nm blue) Single Strip	6
2708	Fiji Blue (450nm blue) Single Strip	7
2709	NUV (410nm violet) Single Strip*	8
2711	Marine White (14000K white) Twin Strips	3
2712	ReefWhite (18000K white) Twin Strips	4
2714	Reef Blue (465nm blue) Twin Strips	5
2715	Fiji Blue (450nm blue) Twin Strips	6
2716	Marine White/Reef Blue Combo Pack	
2717	ReefWhite/Marine Blue Combo Pack	
2718	Fiji Blue/Reef Blue Combo Pack	

*NUV uses SemiLEDs diodes
**controllers sold separately



1

2



Available in UK, EU, US
and AUS versions

3 4 5 6 7 8



3 4 5 6 7 8

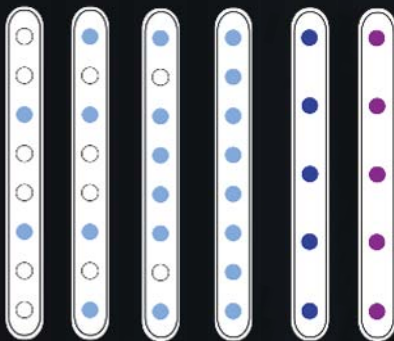

TIP



The NUV strip works on its own in a darkened tank to create amazing coral fluorescence, and even causes fluorescence in other invertebrates and some fish! This light is also good for pigmentation in certain species of coral, particularly species with red pigments such as Lobophyllia and Acanthastrea

- Rugged ABS, aluminium and acrylic housing sealed to IP67
- Wide beam angle (120°)
- Factory serviceable
- Suitable for all types of aquaria
- Creates natural shimmer effect
- Low power consumption (12W) and low running costs
- High energy efficiency
- Long life
- No bulb replacements
- Low voltage
- Uses Cree® LED technology*
- Fully controllable**
- Wide range of mounting options available using the MMS Modular Mounting System
- Hand built in the EU

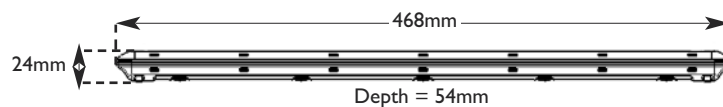

COMPATIBLE WITH
AQUARAY Control
AQUARAY
MODULAR MOUNTING
SYSTEM

GroBEAM

1500 Ultima

Solid State Lighting Tile
for freshwater applications

- 1911 Natural Daylight (6500K) Tile 1
- 1916 Colour Plus Tile 2



AQUABEAM

1500 Ultima NP

Solid State Lighting Tile
wide angle beam for marine applications

- 1915 Ocean Blue (20000K) Tile with NP™ technology 3

AQUABEAM

2000HD Ultima NP

Solid State Lighting Tile
high PAR for marine reef applications

- 1913 ReefWhite (20000K) Tile with NP technology 4

Available in UK, EU, US and AUS versions

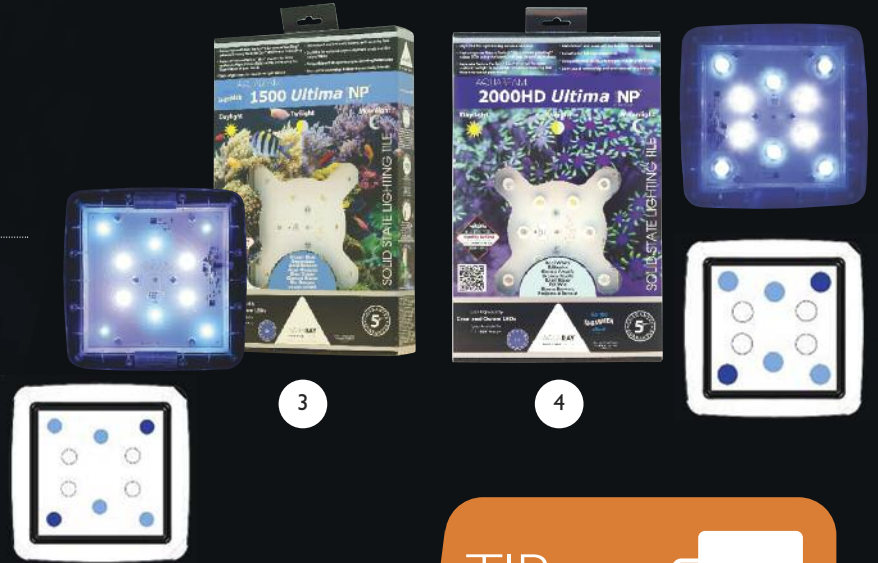

- Rugged ABS, aluminium and acrylic housing sealed to IP67
- Factory serviceable
- Suitable for all types of aquaria
- Creates natural shimmer effect
- Low power consumption (30W) and low running costs
- High energy efficiency
- Long life
- No bulb replacements
- Low voltage
- Uses Cree® and Osram LED technology
- Fully controllable**
- Wide range of mounting options available using the MMS Modular Mounting System
- Hand built in the EU

Nature NP Perfect™ Tropical Marine Centre's patented Nature Perfect™ blue LEDs create incredibly realistic twilight and moonlight whilst enhancing the fluorescence of your corals.



TIP 

As the GroBeam 1500 Ultima ColourPlus tile perfectly matches the photosynthetic action spectrum, it is great for growing plants. It also enhances colours within an aquarium to great effect, just as you would expect!

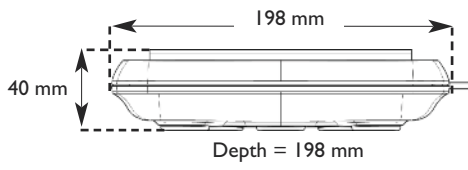

* 2 year guarantee on PSU and 5 year guarantee on lamp unit if unit is registered with us. If not registered, a statutory 2 year guarantee applies on



COLOURPLUS LED1000

Solid State Lighting Tile

1906 ColourPlus 1000 tile 1

MiniLED 400

1860 MiniLED 400 (6500K white) mini tile 2

MiniLED 500HD

for marine reef aquaria

1861 MiniLED 500 (10000K white) mini tile 3

1

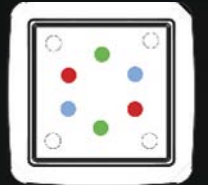

2



3

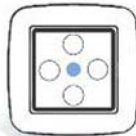

Available in UK, EU, US and AUS versions

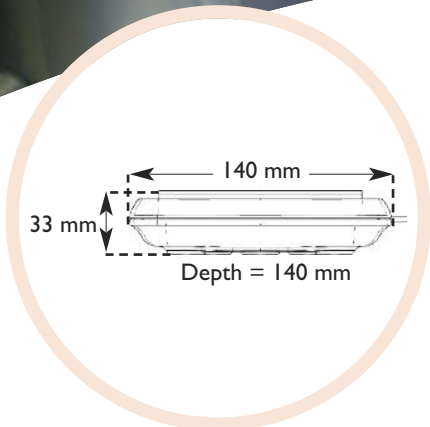

- Rugged ABS, aluminium and acrylic housing sealed to IP67
- Factory serviceable
- Suitable for all types of aquaria
- Creates natural shimmer effect
- Low power consumption and low running costs
- High energy efficiency
- Long life
- No bulb replacements
- Low voltage
- Uses Cree® and Osram LED technology
- Fully controllable**
- MiniLED 500 is manually switchable to a blue moonlight mode
- Wide range of mounting options available using the MMS Modular Mounting System
- Hand built in the EU



* 2 year guarantee on PSU and 5 year guarantee on lamp unit if unit is registered with us. If not registered, a statutory 2 year guarantee applies on both lamp unit and PSU (proof of purchase required).

**controllers sold separately

AquaRay Control

There is a constantly evolving range of controllers for the AquaRay range that use PWM technology to time and dim the LEDs to create sunset, sunrise, daylight and moonlight effects. These are available in 2 channel versions to control 2 strips/mini tiles/combination or 1 tile, and also 8 channels to control 8 strips/minitiles/combination or 4 tiles, or a combination of strips/minitiles/tiles.

All easily programmable via a simple user interface and using a real time clock for accurate timing, these units all have an internal power supply to ensure that your settings are not lost in the event of a power outage.

Controllers that simulate lightning, cloud cover and moon phases are also available.



Available in UK, EU, US and AUS versions

Coming Soon! AquaRay MMS Lighting Hood

This hood assembly works as part of the MMS range to allow lights to be fitted into a hood that can then be suspended, or tank mounted. Although not essential, it gives your array of lights that neat single luminaire look. Dimensions – 550mm x 410mm x 68mm



TIP



When installing in a hood it is best to ensure good ventilation. This will minimise heat build-up and prolong the life of your LEDs.



AQUA RED
FLEXI-LED

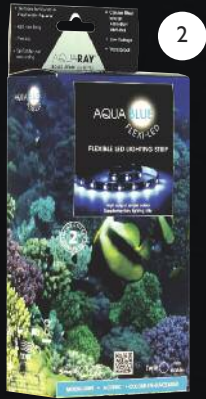

AQUA BLUE
FLEXI-LED

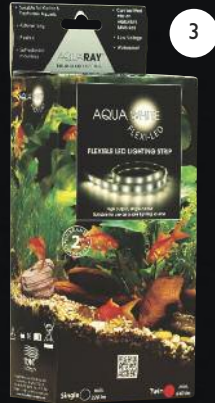

AQUA WHITE
FLEXI-LED

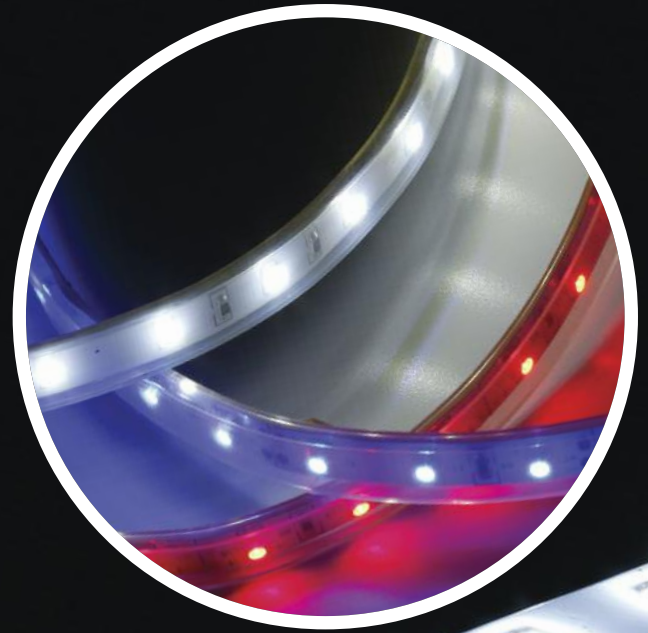

Flexible Lighting Strips

1885	AquaRed Flexi-LED	1
1888	AquaBlue Flexi-LED	2
1889-1	AquaWhite Flexi-LED (6500K) Single	3
1889-2	AquaWhite Flexi-LED (6500K) Twin	3

Available in UK, EU, US
and AUS versions

TIP



The AquaRed Flexi LED can be added to your system to improve the colour rendition of yellows, reds, oranges, and purples in your aquarium. It also makes a great light for night viewing and acclimation, as most aquatic life forms cannot see red

- Flexible, self-adhesive LED lighting strips
- Waterproof and low voltage
- High output, single colour
- Low voltage
- Can be fitted into an AquaRay MMS rail
- 450mm long
- Suitable for marine and freshwater aquaria
- Manually dimmable with an AquaBar Dimmer Switch (sold separately)



AQUABAR

Solid State Lighting Bar

1770	AquaBar 500 Freshwater (white)	1
1771	AquaBar 1000 Freshwater (white)	2
1772	AquaBar 500 Marine (white and blue)	3
1773	AquaBar 1000 Marine (white and blue)	4
1780	AquaBar Dimmer Switch for manual control	5

Available in UK, EU, US
and AUS versions

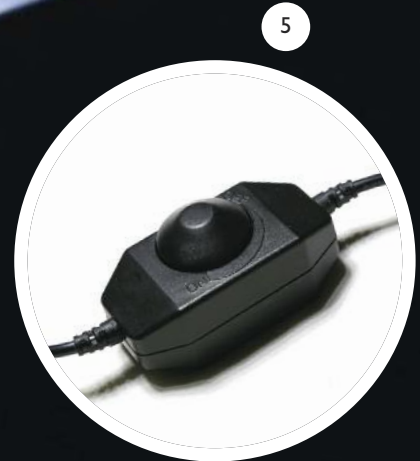
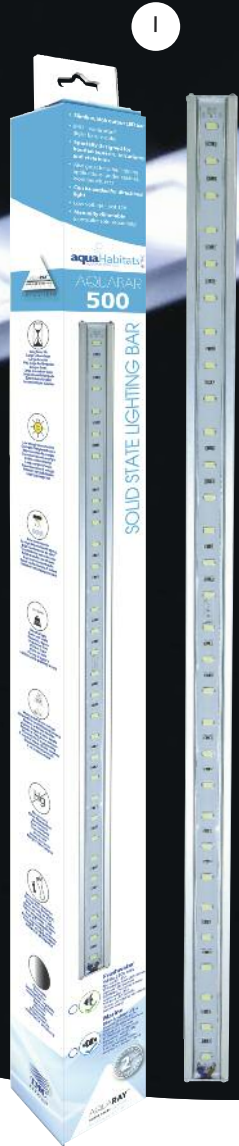

- Slimline, high output lighting strips
- Specially designed for hooded aquariums, terrariums and vivariums
- 500 and 1000mm in length
- Can be angled for directional lighting
- Low voltage
- Fully compatible with the AquaRay MMS range
- Manually dimmable with an AquaBar Dimmer Switch (sold separately)
- Excellent sump lighting
- Also good for other lighting applications (under-cabinet, shelf lighting, task lighting, etc..)

TIP 

When installing your AquaRay lights, make sure that you leave a drip-loop at the point where the cable exits the casing (the cable should be angled slightly downwards at the point of exit). This will prevent water running down the cable and into the casing where it may accumulate and cause damage to the seal over time



Modular Mounting System (MMS) and Accessories

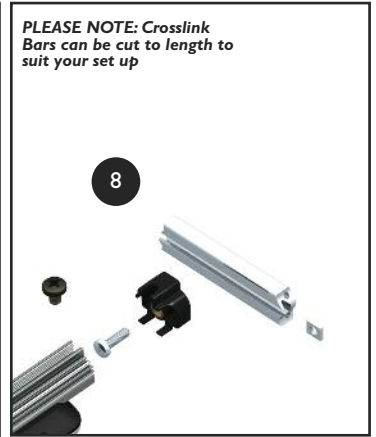
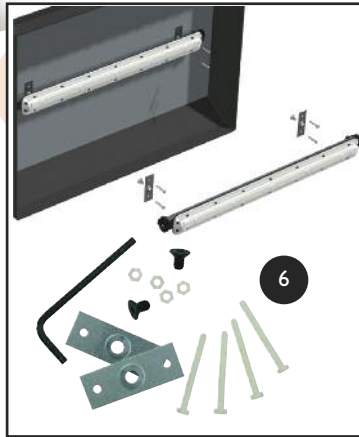

PLEASE NOTE: Crosslink Bars can be cut to length to suit your set up

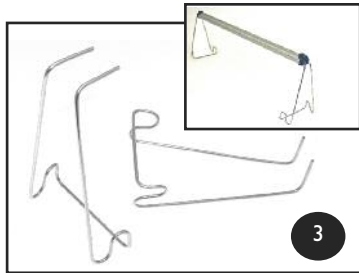

PLEASE NOTE: All MMS Rails can be cut to length to suit your set up

1850	AquaRay MMS Rail 158mm	1
1851	AquaRay MMS Rail 308mm	1
1852	AquaRay MMS Rail 540mm	1
1873	AquaRay MMS Rail 1090mm	1
1874	AquaRay MMS Rail 1610mm	1
1876	AquaRay MMS Rail 2415mm	1
1879	AquaRay MMS End Cap Finishes the rail neatly as well as providing a thread for fixing	2
1893	AquaRay MMS Rim Mount Allows the rail to be mounted from the edges of an aquarium	3
1877	AquaRay MMS T5 End Cap Allows the rail to be fitted into an IP67 T5 fluorescent lamp holder	4
1878	AquaRay MMS T8 End Cap Allows the rail to be fitted into an IP67 T8 fluorescent lamp holder	5
1881	AquaRay MMS Mounting Bracket Allows the rail to be mounted to a surface	6
1823	AquaRay MMS Suspension Kit Allows the rail to be suspended from a ceiling	7
1883	AquaRay MMS Adjustable Link Bar Connects two or more rails together at any desired distance apart to form an array. It also allows the rails to be angled in order to direct the light where it is needed.	8
1884USB	AquaRay MMS USB extension cable 3m extension cable for the lights. Use a maximum of 1 per power supply or controller output.	9
1824	AquaRay MMS Cable Wrap Keeps cables looking neat and tidy	10

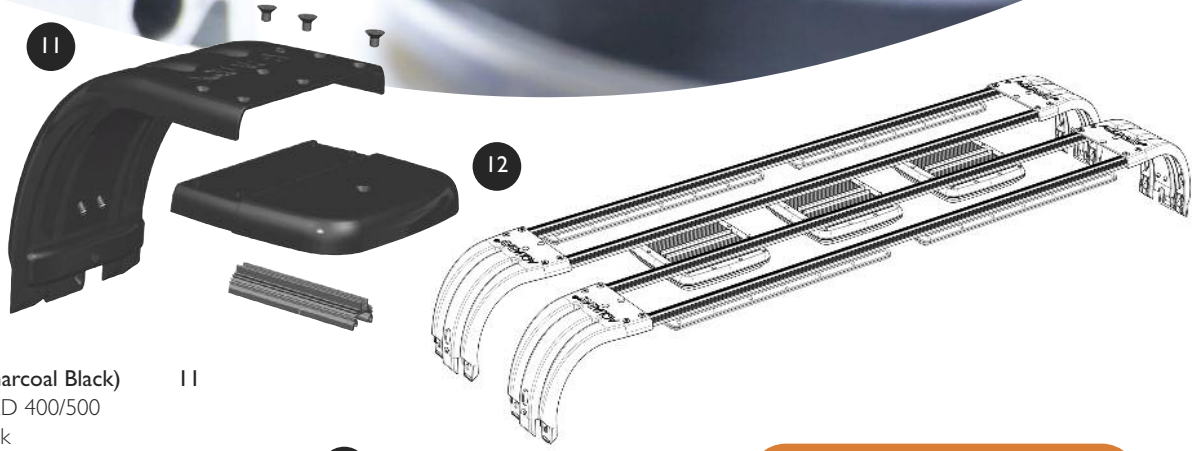

- 1831 **MountaRay Single (Charcoal Black)** 11
For mounting a MiniLED 400/500 from the edge of a tank

- 1832 **MountaRay Pair (Charcoal Black)** 12
For supporting an array of AquaRay lighting over an aquarium. Colour matched to TMC's Signature tank range

- 1832-W **MountaRay Pair (Glacier White)** 12
For supporting an array of AquaRay lighting over an aquarium. Colour matched to TMC's Signature tank range

- 1832-G **MountaRay Pair (Carbon Grey)** 12
For supporting an array of AquaRay lighting over an aquarium. Colour matched to TMC's Signature tank range

- 1886 **AquaRay Cleaning Cloth** 13
AquaRay branded microfibre cleaning cloth to help maintain your aquarium lighting

- 1890 **AquaHabitats EasiFit Mounting Kit 1** 14
Allows an AquaGro MicroHabitat 8, a biOrb or biUbe (except Baby biOrb) and other "lifestyle" tanks to upgrade to a MiniLED 400/500 tile. Slot together - no tools required

- 1891 **AquaHabitats EasiFit Mounting Kit 2** 15
Allows a MicroHabitat 15 tank to use a MiniLED 400/500 tile. Slot together - no tools required

- 1892 **AquaHabitats EasiFit Kit 3** 16
Allows a MicroHabitat 30 tank to use an AquaBeam 1500 or 2000 tile. Slot together - no tools required



TIP 

The AquaRay MMS rail can easily be cut to length with a hacksaw, and together with all the other accessories available, this allows AquaRay lighting to be fitted to just about any aquarium

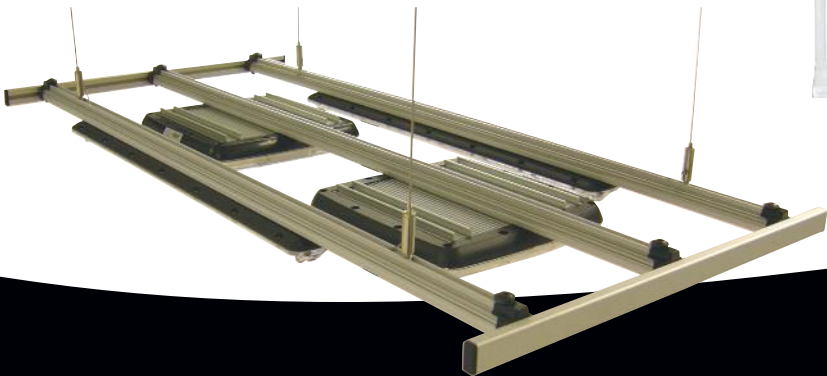

AQUABEAM
600 Ultima Marine White

LEDs 6 x Cree® ML-E Ocean White 2 x Cree® ML-E Reef Blue	PAR at 400mm in air 50 μ Einsteins/sec/m ²
Beam Angle 120°	Illuminance at 400mm in air 2250 lux
Correlated Colour Temp. 14000 K	Total Luminous Flux 864 lumens
	Total Power Consumption (inc.PSU) 12W at 700mA
	Efficacy 79 lm/W

AQUABEAM
600 Ultima Reef White

LEDs 4 x Cree® ML-E Ocean White 4 x Cree® ML-E Reef Blue	PAR at 400mm in air 48 μ Einsteins/sec/m ²
Beam Angle 120°	Illuminance at 400mm in air 1990 lux
Correlated Colour Temp. 18000 K	Total Luminous Flux 726 lumens
	Total Power Consumption (inc.PSU) 12W at 700mA
	Efficacy 61 lm/W

AQUABEAM
600 Ultima Marine Blue

LEDs 2 x Cree® ML-E Ocean White 6 x Cree® ML-E Reef Blue	PAR at 400mm in air 45 μ Einsteins/sec/m ²
Beam Angle 120°	Illuminance at 400mm in air 1870 lux
Correlated Colour Temp. 20000 K	Total Luminous Flux 528 lumens
	Total Power Consumption (inc.PSU) 12W at 700mA
	Efficacy 44 lm/W

AQUABEAM
600 Ultima Reef Blue

LEDs 8 x Cree® ML-E Reef Blue	PAR at 400mm in air 44 μ Einsteins/sec/m ²
Beam Angle 120°	Illuminance at 400mm in air 1650 lux
Peak Wavelength 465nm	Total Luminous Flux 351 lumens
	Total Power Consumption (inc.PSU) 12W at 700mA
	Efficacy 30 lm/W

AQUABEAM
600 Ultima Fiji Blue

LEDs 5 x Cree® XT-E Fiji Blue	PAR at 400mm in air 38 μ Einsteins/sec/m ²
Beam Angle 120°	Illuminance at 400mm in air 1200 lux
Peak Wavelength 450nm	Total Luminous Flux 206 lumens
	Total Power Consumption (inc.PSU) 12W at 700mA
	Efficacy 17 lm/W

GroBEAM
600 Ultima Natural Daylight

LEDs 5 x Cree® XB-D Natural Daylight	Illuminance at 400mm in air 2650 lux
Beam Angle 120°	Total Luminous Flux 1029 lumens
Correlated Colour Temp. 6500 K	Total Power Consumption (inc.PSU) 12W at 700mA
PAR at 400mm in air 61 μ Einsteins/sec/m ²	Efficacy 86 lm/W

MiniLED 400

LEDs 4 x Osram Oslon Natural Daylight	Illuminance at 400mm in air 2040 lux
Beam Angle 80°	Total Luminous Flux 633 lumens
Correlated Colour Temperature 6603 K	Total Power Consumption (inc.PSU) 10W at 700mA
PAR at 400mm in air 62 μ Einsteins/sec/m ²	Efficacy 64 lm/W

MiniLED 500HD

LEDs 4 x Cree® XP-E Ocean White 1 x Cree® XP-E Reef Blue	Illuminance at 400mm in air 7550 lux
Beam Angle 60°	Total Luminous Flux 724 lumens
Correlated Colour Temperature 13254 K	Total Power Consumption (inc.PSU) 11W at 700mA
PAR at 400mm in air 143 μ Einsteins/sec/m ²	Efficacy 66 lm/W

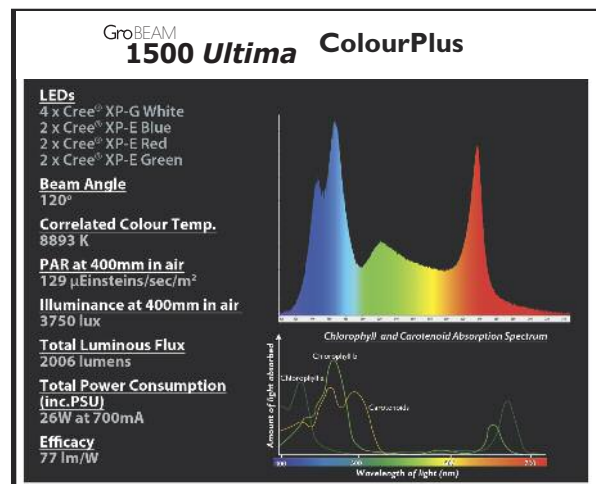
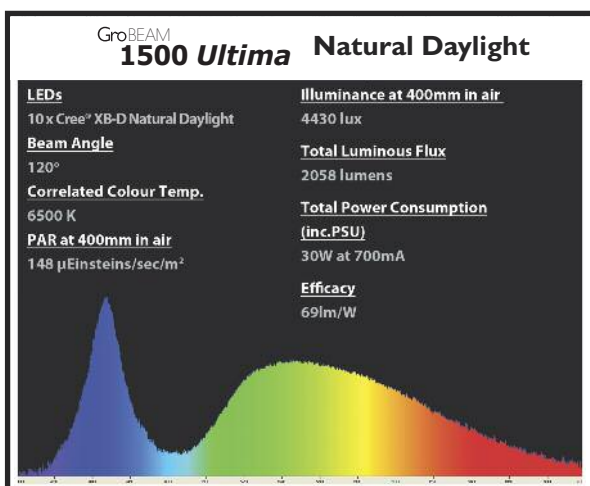
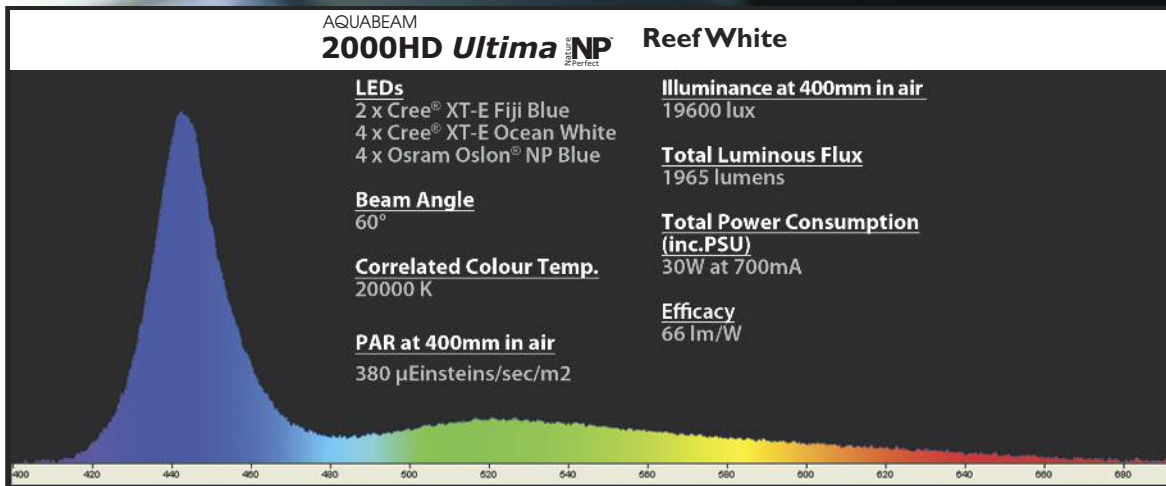
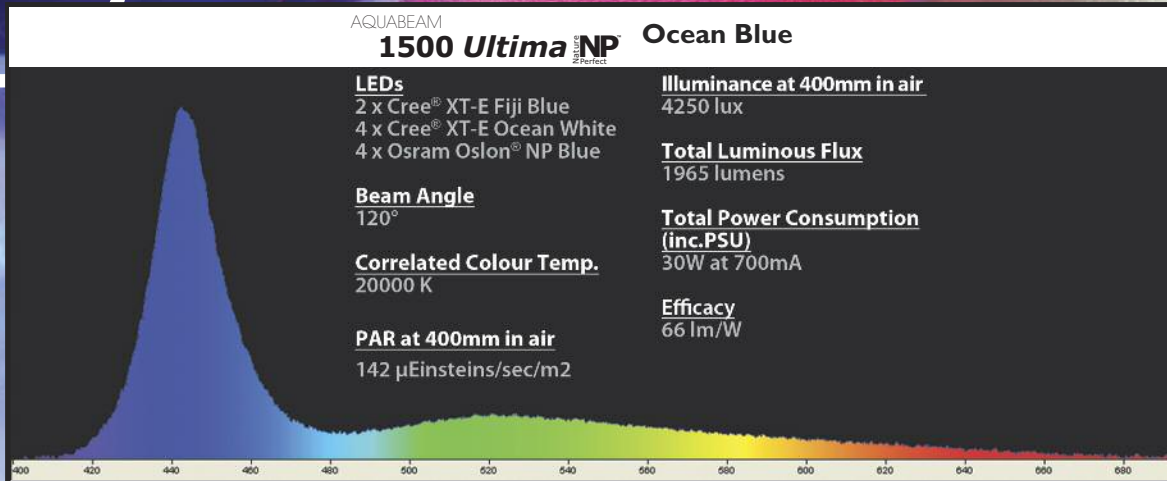

6 Mounting options



MountaRay Bracket (single)

Suitable for mounting an AquaRay MiniLED 400/500 over nano aquaria up to approx. 400 x 400mm (16" x 16")

You will need:

- 1 x MountaRay Bracket (single)
- 1 x AquaRay MiniLED 400 (freshwater) OR
- 1 x AquaRay MiniLED 500 (marine)

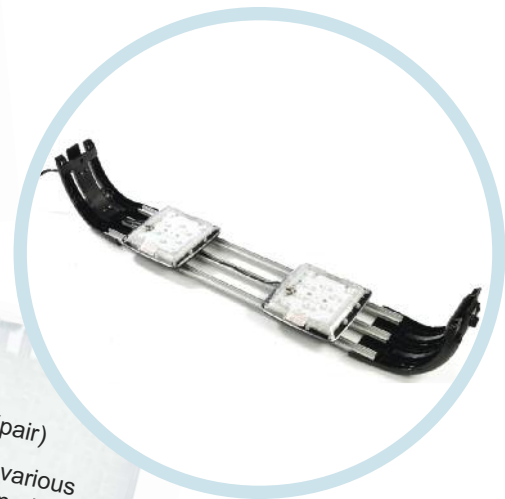

MountaRay Bracket (pair)

Suitable for mounting single or multiple AquaRay units over aquaria up to approx. 1800 x 600mm (6' x 2')

You will need:

- 1 x MountaRay Bracket (pair)
- 3 x MMS rail (available in various lengths which can be trimmed to size – see p.24)
- Selected AquaRay lighting units



MountaRay Bracket (2 pairs)

Suitable for mounting multiple AquaRay units over aquaria up to approx. 2000 x 1200mm (6'6" x 4')

You will need:

- 2 x MountaRay Bracket (pair)
- 6 x MMS rail (available in various lengths which can be trimmed to size – see p. 24)
- Selected AquaRay lighting units

Modular Mounting Frame

Self-assembly frame which can be suspended using a suspension kit, or installed within an aquarium hood.

You will need:
1 x MMS Crosslink Bar (pair)
3 or 4 x MMS rail (available in various lengths which can be trimmed to size – see p.24)
Pair of MMS end-caps for each rail
Selected AquaRay lighting units

TIP



Inspect and clean your AquaRay units regularly - this will ensure that the quality of the light is not impeded by salt and other deposits on the lens, that the heat sink is not obscured and will also reduce the long-term, potentially damaging, effects of salt and moisture to the casing seal and internal electronic components

COMING SOON!

AquaRay MMS Lighting Hood

Supplied with MMS rail, this can be suspended or mounted to the rim of the aquarium. Can be fitted with various combinations of AquaRay lights as required.

Suitable for aquaria from approx. (600 x 600mm to 900 x 600mm (2' x 2' to 3' by 2')

MMS AquaRail Fixing Bracket

Supplied with fixing kit for installation in aquarium hood as required.

7 Research & Development

The future

The AquaRay range is designed with the future in mind.

Wherever possible, new products will always be retro-compatible with your existing set up. Although the LED industry moves extremely quickly, your lights and controllers will work together whether they are old or new.

In this way you can easily upgrade your lighting gradually, or perhaps continue to use your old kit with a newer controller:

LED is a very fast-paced, exciting technology and Tropical Marine Centre thrives on research and development.

We have been involved with LED lighting since its introduction to the hobby in 2007 and we constantly look for new lighting technologies that could perhaps be adapted for aquarium use.

When they appear, our aim is to make them accessible to the hobby with high quality products at affordable prices.

Because of this philosophy, AquaRay lighting is now one of the world's most-established and popular aquarium LED lighting brands and we look forward to bringing many more new products to you in the future.





Commercial range

AquaRay lighting suits many commercial applications and in fact we have products within the range that are specifically dedicated to commercial purposes.

These range from specialist colour lighting tiles, to high power LED floodlights and IP68 LED strips. We have worked successfully with shop installers, public aquaria, hatcheries and coral research centres all over the world.

If you have a commercial application, please give us a call on +44 (0)1923 284151 to discuss the options available.

“ I've been using the TMC AquaRay LED lighting range for years with great success, growing any plant I wish with ease. My current set up with GroBeam I500 Ultima tiles is particularly impressive with great PAR output, as well as cool and crisp colour rendition perfect for modern aquascaping. I've tried more expensive and higher end units and the I500 tile remains my favourite by far in terms of form, function, quality and value. ”

George Farmer - Planted Tank Expert



“ TMC were the first to bring affordable and useable LED lighting systems to the UK market and their range of tiles and strips continues to be highly regarded today. I've used several TMC AquaRays myself and continue to do so. The products, the customer support and the company's ethos make TMC one of the best ”

Richard Aspinall - Editor, Ultramarine Magazine

“ I am using the AquaBeam 600 Reef Blue to demonstrate coral fluorescence. Our students and visitors are always deeply impressed by the spectacular glow of the corals under this type of lighting. ”

Dr. Jörg Wiedenmann - Head of the Coral Reef Laboratory, National Oceanography Centre University of Southampton

“ After keeping fish for many years and using different lighting systems, I was always dubious about using LED lighting as the primary source of light for an aquarium, especially a reef system. Surely LEDs cannot produce the amount of light corals need to sustain good health and growth? Well after purchasing and using the AquaRay AquaBeam 600 Ultra Duo all of my doubts have been put to bed - they are simply amazing. My corals have never opened up as much until I installed AquaRay lighting. They give a great shimmer effect and save me a lot of money in electricity and replacement lamps. I would highly recommend these to anyone considering using them - you will not be disappointed. ”

Jay Lambert - Owner of saltytank.com



“ We are currently using AquaBeam 600 strips and AquaBeam 1000 tiles in all our small to medium size tanks. These lights have been a revelation, totally transforming every one of these displays - animals that previously looked drab and uninteresting are now alive with colour! The lights are incredibly easy to install and use, with a wealth of different settings and the electricity savings have been incredible. ”

Matt Davidson - Aquarist, Anglesey Sea Zoo

“ I get a lot of LED lights in for review at Practical Fishkeeping but few live up to what should have been the core values of LED - low energy, low heat, high output, safe, silent, versatile, waterproof lighting. The TMC AquaRay range is all of the above and is even assembled here in the UK. They do genuine R&D in an economic climate when many just buy wholesale from China, and work with some leading scientific institutions, as well as continually getting feedback from consumers and retailers, and in turn tweaking the range accordingly. PFK readers love them, and I've used and recommended them extensively, both for fresh and salt water. ”

Jeremy Gay - Editor, Practical Fishkeeping Magazine

“ Having had the opportunity to undertake several product reviews of the TMC AquaRay range and undertaking extensive PAR analyses I was impressed that they matched or even exceeded the output of more traditional T5 and metal halide lighting solutions. Not only can these products supply the lighting requirements of even the most light demanding corals, they produce negligible heat transfer to the aquarium which in itself can be a massive cost saving! This combined with the modular nature of the products which can expand as your aquarium grows means that these are truly one of the best lighting products available in the hobby. ”

Levi Major - Freelance Aquatic Writer

“ The ColourPlus tiles are a proven performer in terms of plant growth, with their RGB LEDs making the colours of fish and plants really pop. ”

George Farmer - Planted Tank Expert

TMC®

London

Solesbridge Lane
Chorleywood
Hertfordshire
WD3 5SX
England

t: +44 1923 284151
f: +44 1923 285840

london@tropicalmarinecentre.co.uk

TMC®

Manchester

Unit 3, Beta Court
Sharston Industrial Estate
Wythenshawe
Manchester, M224QE
England

t: +44 161 946 1538
f: +44 161 998 9599

manchester@tropicalmarinecentre.co.uk

TMC®

Bristol

Unit 2
Cribbs Causeway Centre
The Laurels
Cribbs Causeway, Bristol
BS10 7TT, England

t: +44 117 958 1150
f: +44 117 958 1152

bristol@tropicalmarinecentre.co.uk

TMC®

Iberia

Rua Cidade de Paris, n.o 6
Parque Industrial do Arneiro
2660-456 S. Julião do Tojal,
Loures, Portugal

t: +351 219739140
f: +351 219739141

iberia@tropicalmarinecentre.co.uk



www.tropicalmarinecentre.co.uk